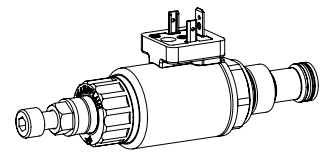

Proportional pressure relief cartridge inverse

- ◆ direct operated
- ◆ $Q_{max} = 25 \text{ l/min}$
- ◆ $p_{max} = 400 \text{ bar}$
- ◆ $p_{Nmax} = 350 \text{ bar}$

M22 x 1,5
ISO 7789

DESCRIPTION

Direct operated proportional pressure relief valve with inverse function in screw-in cartridge construction for cavity according to ISO 7789. Good flow capacity due to the differential area principle, very sensitively adjustable. When the operating pressure adjusted by means of the proportional solenoid is reached, the valve opens and connects the protected line with the drain to the tank. With the solenoid deenergised, maximum working pressure is present. If the solenoid current increases, the pressure in port P (1) drops. The back pressure in T (2) affects the pressure in P (1). For the control, Wandfluh proportional amplifiers are available (see register 1.13).

APPLICATION

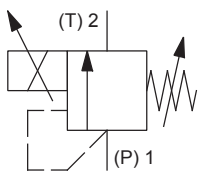
The electrical remote control in conjunction with process controls allows economical solutions with repeatable processes. By means of the inverse function, the maximum system pressure is maintained if the electrical valve control falls out (safety function). The screw-in cartridge is perfectly suitable for installation in control blocks and is installed in sandwich- (vertical stacked systems) and in flange plates (corresponding data sheets in this register). For machining the cartridge cavity in steel and aluminum blocks, cavity tools are available (hire or purchase). Please refer to the data sheets in register 2.13.

SYMBOL

ACTUATION

Actuation	Proportional solenoid, wet pin push type, pressure tight
Execution	W.S37 / 19 x 50 (Data sheet 1.1-173) M.S35 / 19 x 50 (Data sheet 1.1-174)
Connection	Connector socket EN 175301 – 803 Connector socket AMP Junior-Timer Connector Deutsch DT04 – 2P

TYPE CODE

Pressure relief valve					B	D	I	PM22	-		-		/			-		#	
Direct operated																			
Proportional, inverse																			
Screw-in cartridge M22 x 1,5																			
Nominal pressure range p_N	20 bar	<input type="text" value="20"/>	200 bar	<input type="text" value="200"/>															
	100 bar	<input type="text" value="100"/>	315 bar	<input type="text" value="315"/>															
	160 bar	<input type="text" value="160"/>	350 bar	<input type="text" value="350"/>															
Nominal voltage U_N	12 VDC	<input type="text" value="G12"/>																	
	24 VDC	<input type="text" value="G24"/>																	
	without coil	<input type="text" value="X5"/>																	
Slip-on coil	Metal housing round																		
	Metal housing square																		
Connection execution	Connector socket EN 175301-803 / ISO 4400																		
	Connector socket AMP Junior - Timer																		
	Connector Deutsch DT04 - 2P																		
Sealing material	NBR	<input type="text" value=""/>																	
	FKM (Viton)	<input type="text" value="D1"/>																	
Design index (subject to change)																			

2.3-548

GENERAL SPECIFICATIONS

Designation	Proportional pressure relief valve with inverse function
Construction	Direct operated
Mounting	Screw-in cartridge construction
Nominal size	M22 x 1,5 according to ISO 7789
Actuation	Proportional solenoid
Ambient temperature	-25...+70 °C
Weight	0,60 kg
MTTFd	150 years

ELECTRICAL SPECIFICATIONS

Protection class	Connection execution D: IP65 Connection execution J: IP66 Connection execution G: IP67 and IP69K
Relative duty factor	100 % DF
Standard nominal voltage	12 VDC, 24 VDC
Limiting current at 50 °C	$I_G = 1320 \text{ mA}$ ($U_N = 12\text{VDC}$) $I_G = 660 \text{ mA}$ ($U_N = 24\text{VDC}$)

Note! Other electrical specifications see data sheet 1.1-173 (slip-on coil W) and 1.1-174 (slip-on coil M)



HYDRAULIC SPECIFICATIONS

Working pressure	$p_{\max} = 400 \text{ bar}$
Nominal pressure range	$P_N = 20 \text{ bar}, 100 \text{ bar}, 160 \text{ bar}, 200 \text{ bar}, 315 \text{ bar}, 350 \text{ bar}$ Adjustable via adjustment screw (-20 % / +30 %)
Maximum volume flow	$Q_{\max} = 25 \text{ l/min}$ ($p_N = 20 / 100 / 160 / 200 \text{ bar}$) $Q_{\max} = 15 \text{ l/min}$ ($p_N = 315 / 350 \text{ bar}$) $Q_{\max} = 5 \text{ l/min}$
Minimum volume flow	$Q_{\min} = 0,2 \text{ l/min}$
Leakage oil	See characteristics
Hysteresis	$\leq 4 \%$ at optimal dither signal
Repeatability	$\leq 2 \%$ at optimal dither signal
Fluid	Mineral oil, other fluid on request
Viscosity range	12 mm ² /s...320 mm ² /s
Temperature range fluid	-25...+70 °C (NBR) -20...+70 °C (FKM)
Contamination efficiency	Class 18 / 16 / 13
Filtration	Required filtration grade $\beta_{6...10} \geq 75$, see data sheet 1.0-50

PERFORMANCE SPECIFICATIONS

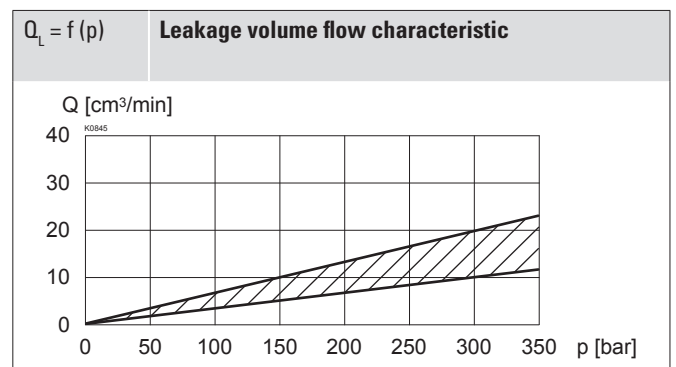
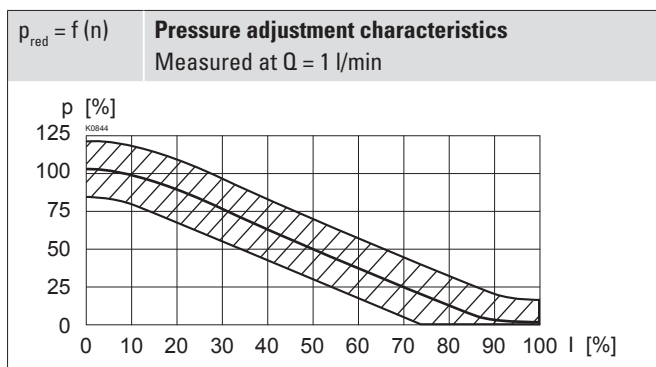
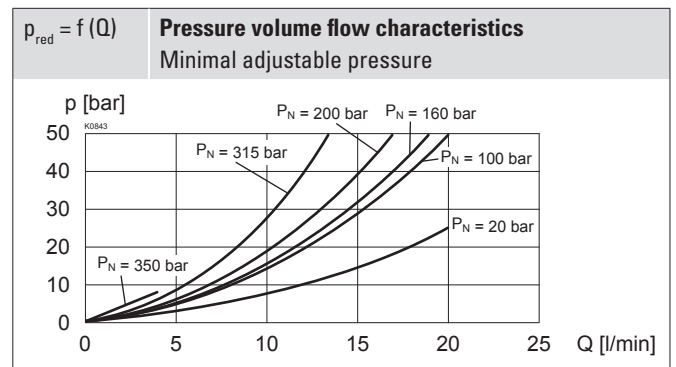
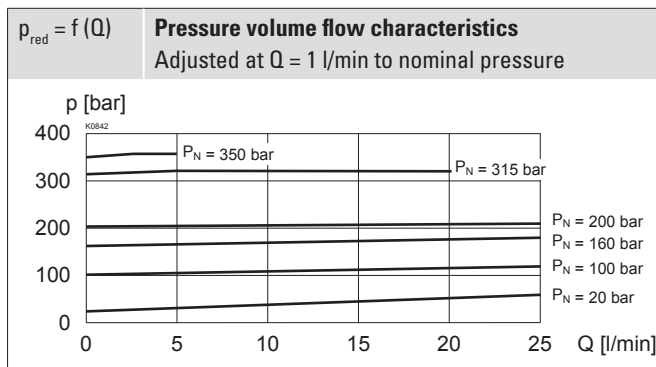
Oil viscosity $\nu = 30 \text{ mm}^2/\text{s}$

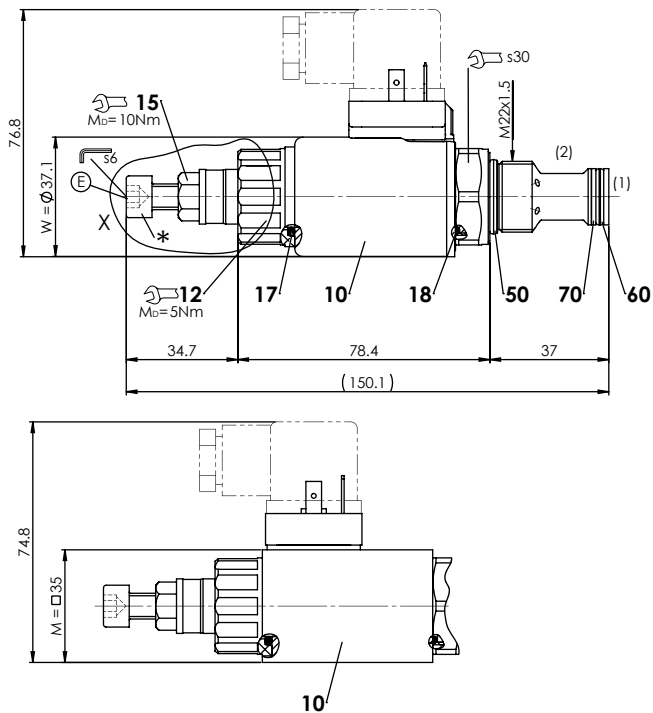

DIMENSIONS

E = Air bleed screw

*Adjustment screw for adjusting the nominal pressure

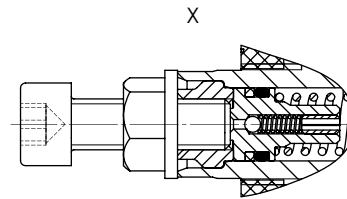
HYDRAULIC CONNECTION

Cavity drawing according to ISO 7789-22-02-0-98

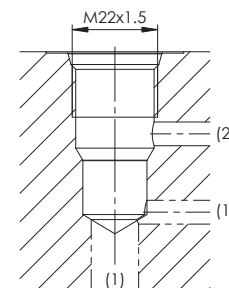
Note!

For detailed cavity drawing and cavity tools see data sheet 2.13-1003

PARTS LIST

Position	Article	Description
10	206.2...	W.S37 / 19 x 50
	260.5...	M.S35 / 19 x 50
	154.2700	Knurled nut
	153.2401	Dichtmutter Norm „Seal-Lock“ 8 Zi - Ni M8
	160.2187	O-ring ID 18,72 x 2,62 (NBR)
	160.2170	O-ring ID 17,17 x 1,78 (NBR)
	160.2188	O-ring ID 18,77 x 1,78 (NBR)
	160.6188	O-ring ID 18,77 x 1,78 (FKM)
	160.2140	O-ring ID 14,00 x 1,78 (NBR)
	160.6141	O-ring ID 14,00 x 1,78 (FKM)
	049.3177	Back-up ring rd 14,6 x 17,5 x 1,4

COMMISSIONING

When commissioning, the valve must be vented under pressure as follows (see detail X in Dimensions):

- ◆ Loosen lock nut
- ◆ Remove screw (E)
- ◆ Push the non-return valve (with pin or hex key < 1,3 mm)
- ◆ Screw-in the screw (E)
- ◆ Adjust the required pressure and tighten the lock nut

Attention!

Therewith oil flows out with the corresponding pressure! Cover with a cloth.

MANUAL OVERRIDE

None

STANDARDS

Cartridge cavity	ISO 7789
Solenoids	DIN VDE 0580
Connection execution D	EN 175301 – 803
Protection class	EN 60 529
Contamination efficiency	ISO 4406

ACCESSORIES

Proportional amplifier	Register 1.13
Electric plug B (black)	Article no. 219.2002
Flange body / sandwich plate NG4-Mini	Data sheet 2.3-720
Flange body / sandwich plate NG6	Data sheet 2.3-740
Flange body / sandwich plate NG10	Data sheet 2.3-760
Threaded body	Data sheet 2.9-200
Technical explanations	Data sheet 1.0-100
Filtration	Data sheet 1.0-50

SEALING MATERIAL

NBR or FKM (Viton) as standard, choice in the type code

SURFACE TREATMENT

- ◆ The cartridge body made of steel and the slip-on coil are zinc-nickel coated

INSTALLATION NOTES

Mounting type	Screw-in cartridge M22 x 1,5
Mounting position	Any, preferably horizontal
Tightening torque	$M_0 = 60$ Nm Screw-in cartridge $M_0 = 5$ Nm knurled nut